

RECOMMENDED PC BOARD LAYOUT
WITHOUT MOUNTING POSTS

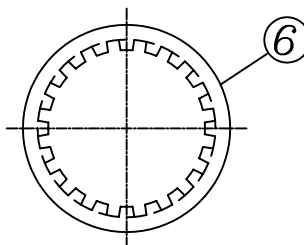

LOCK WASHER

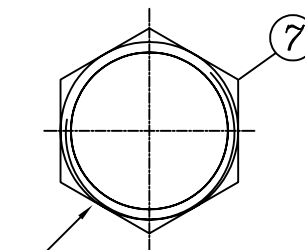

1/2-28UNEF-2B
CLAMP NUT

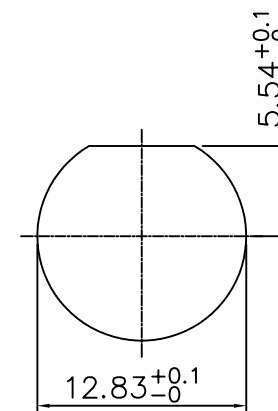

RECOMMENDED MOUNTING HOLE
MAXIMUM PANEL THICKNESS: 5.5MM

MATERIAL & FINISH

- ① CENTER CONTACT : BRONZE, GOLD PLATING
- ② BODY : ZINC ALLOY NICKEL PLATING
- ③ INSULATOR : PE-606
- ④ MOUNTING POST : BRONZE, TIN PLATING
- ⑤ SOLDER TAIL : COPPER WIRE, TIN PLATING
- ⑥ WASHER : STEEL, NICKEL PLATING
- ⑦ NUT : BRASS, NICKEL PLATING
- ⑧ HOUSING : PBT (94 V-0)

Note:
Tolerances:
X. ±0.5
X.X ±0.3
X.XX±0.2

YEAR ROUND Technology Corp. TEL: 886 2 22901234 www.yr.com.tw		Title		
		50 OHM BNC VERTICAL PCB/PANEL MOUNT JACK		
P/N	5BV-01211	Checked By	Drawn By	Approved By
D/N	5BV-01211,R			
SCALE	2:1			
UNIT		MM		

Revised dimensions and description

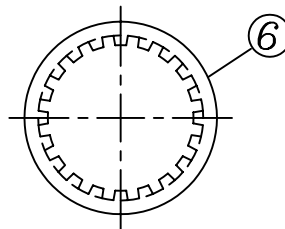
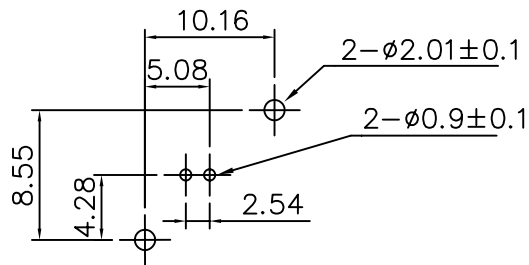
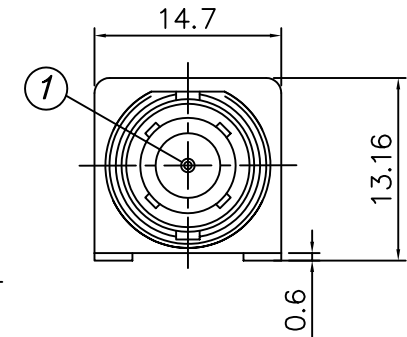
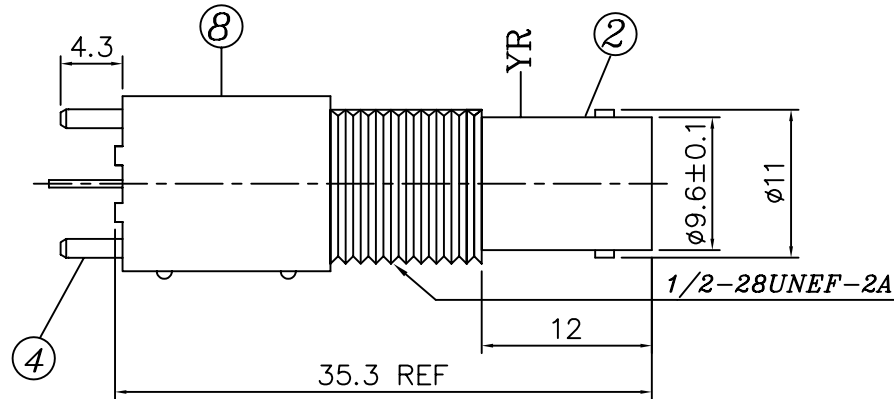
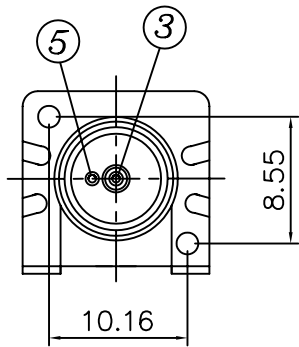

LOCK WASHER

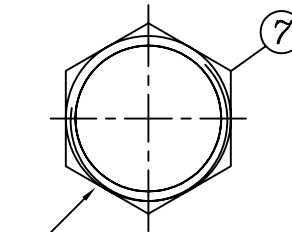

1/2-28UNEF-2B
CLAMP NUT

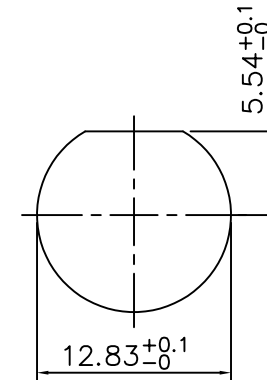

RECOMMENDED MOUNTING HOLE
MAXIMUM PANEL THICKNESS: 5.5MM

RECOMMENDED PC BOARD LAYOUT
WITHOUT MOUNTING POSTS

MATERIAL & FINISH

- ① CENTER CONTACT : BRONZE, GOLD PLATING
- ② BODY : ZINC ALLOY NICKEL PLATING
- ③ INSULATOR : PE-606
- ④ MOUNTING POST : BRONZE, TIN PLATING
- ⑤ SOLDER TAIL : COPPER WIRE, TIN PLATING
- ⑥ WASHER : STEEL, NICKEL PLATING
- ⑦ NUT : BRASS, NICKEL PLATING
- ⑧ HOUSING : PBT (94 V-0)



YEAR ROUND Technology Corp.

TEL: 886 2 22901234 www.yr.com.tw

Title	75 OHM BNC VERTICAL PCB/PANEL MOUNT JACK			
P/N	7BV-01211	Checked By	Drawn By	Approved By
D/N	7BV-01211,R	柯 93,06,08 宏融	趙 93,06,08 龍鴻	白 93,06,08 添發
SCALE	2:1	REV	2	
		UNIT	MM	

Note:
Tolerances:
X. ±0.5
X.X ±0.3
X.XX±0.2

Revised dimensions and description